

## Intelligent Pump Drive

200-240V Three Phase: 3/4 to 175 HP

380-480V Three Phase: 1 to 1000 HP

500-600V Three Phase: 2 to 250 HP



**iQPUMP® 1000**  
Intelligent Pump Controller

# iQpump1000: Your Total Pumping Solution



Yaskawa designed the iQpump<sup>®</sup>1000 with pump service operators and pump system owners in mind. iQpump1000 offers ease of setup and comprehensive pump and motor protection features.

The integrated pump specific software and set up parameters allow the operator to program control values for a wide range of applications. The iQpump1000 drive will automatically adjust pump operating conditions, as the process variables change while still maintaining optimum pump performance and protection.

iQpump1000 can also replace phase converters when converting from a single-phase to a three-phase pump motor.

The flexibility of the iQpump1000 allows for three main control methods from single to multi-pump applications.

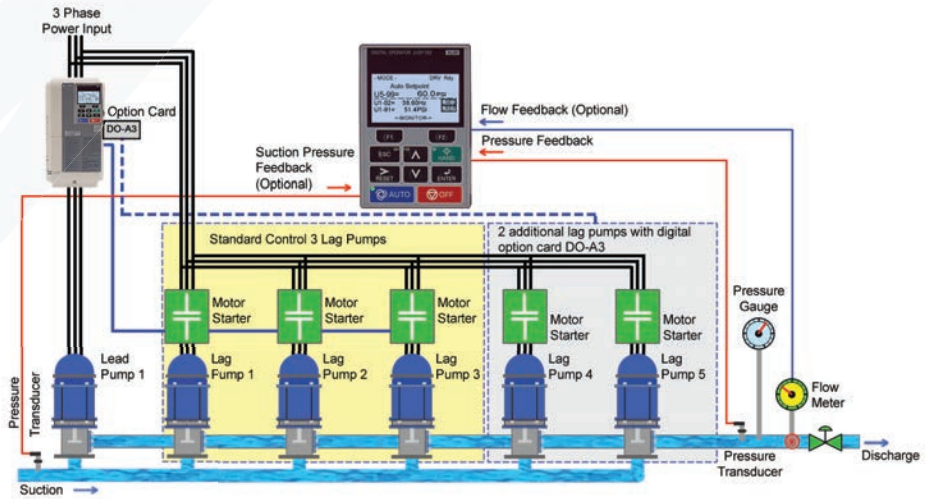

Drive with Constant Speed Lag Pump Multiplexing: Supports up to 5 Lag Pumps



Simplex Pump System

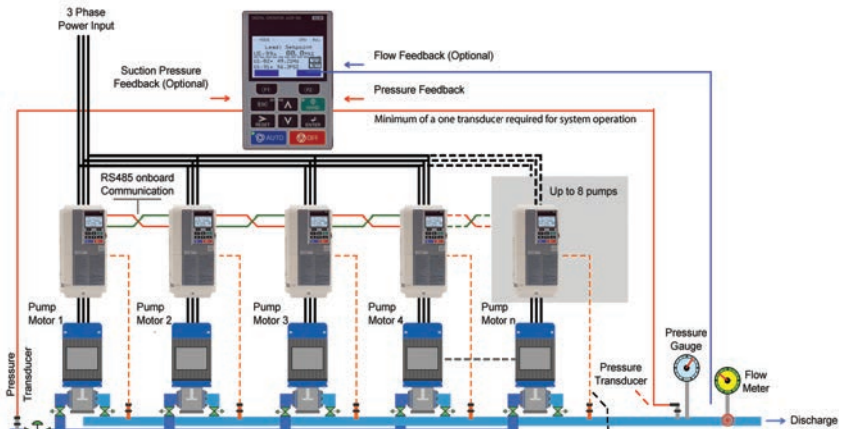

Drive to Drive Pump Multiplexing: Supports up to 8 Pumps

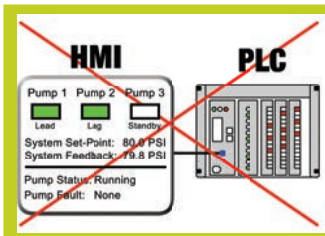

No PLCs, HMIs or external control relays are required for the pump logic control, therefore reducing total system cost.

# iQpump1000: Your Total Pumping Solution



Yaskawa designed the iQpump<sup>®</sup>1000 with pump service operators and pump system owners in mind. iQpump1000 offers ease of setup and comprehensive pump and motor protection features.

The integrated pump specific software and set up parameters allow the operator to program control values for a wide range of applications. The iQpump1000 drive will automatically adjust pump operating conditions, as the process variables change while still maintaining optimum pump performance and protection.

iQpump1000 can also replace phase converters when converting from a single-phase to a three-phase pump motor.

The flexibility of the iQpump1000 allows for three main control methods from single to multi-pump applications.

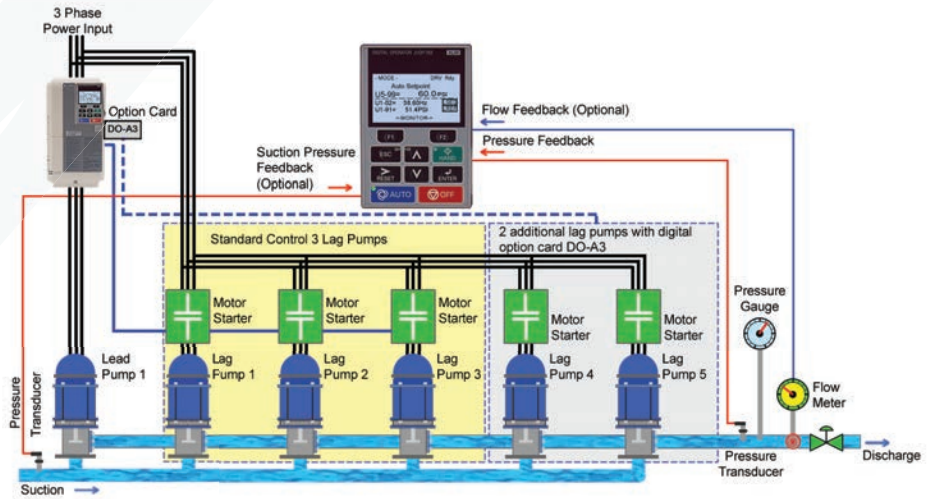

**Drive with Constant Speed Lag Pump Multiplexing: Supports up to 5 Lag Pumps**



**Simplex Pump System**

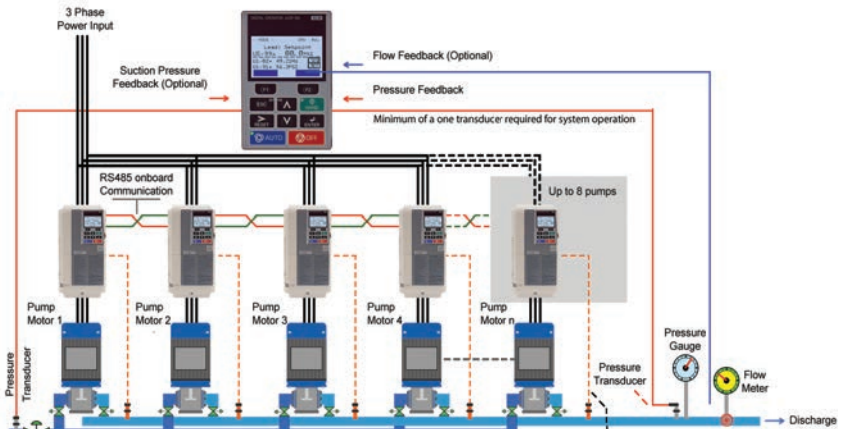

**Drive to Drive Pump Multiplexing: Supports up to 8 Pumps**

**HMI**

**PLC**

No PLCs, HMIs or external control relays are required for the pump logic control, therefore reducing total system cost.

# System Benefits

## Improved Process Control

By matching pump output flow or pressure directly to the process requirements, applications can be fine tuned more rapidly by iQpump1000 than by other control forms.

## Improved System Reliability

Any reduction in speed achieved by using iQpump1000 has major benefits in reducing pump wear, particularly in bearings and seals.

## Reduce Total System Cost

iQpump1000 lowers system cost by eliminating sensors, jockey pumps, restriction valves, as well as reducing pressure tank sizing.

## Energy Savings

Depending on the application, iQpump1000 reduces the demand for energy by 20 to 50% by adjusting pump speed to match a lower flow/pressure.

## Ease of Installation and Set Up

iQpump1000 uses pump terminology on all setup parameters and monitors. Application presets apply most of the parameters for you. Also included is a "Pump Quick Setup" and "Modified Constants" menu.

## Eliminate Complex Control Panels

By installing iQpump1000, many electromechanical controls can be eliminated. This reduces the maintenance that these panels require.

## Reduce Mechanical Stress and Damage to Pumps

iQpump1000 has soft-start and soft-stop capabilities, which eliminate pressure surges and water hammer.

## Cooler Running Pump Motor

Soft start eliminates inrush current, dramatically increasing winding insulation life.

- Commercial and Residential Irrigation, Fluid Storage Tanks
- Settling Ponds, Sewage Lift Stations
- Booster Pump Stations (Municipal, High-rises, Condos, Apartment Complexes, Residential Developments)



# Designed with Pump Operators in Mind

Designed with the user in mind, iQpump1000 uses intuitive pump related terminology, with simple process control selection of engineering units such as PSI, GPM, Feet, Metric, Temperature, Inches of Mercury, and many other process control units.

## Pump Specific HOA Operator

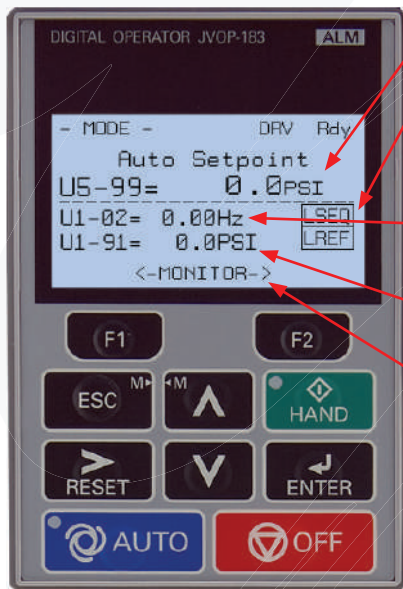

System Pressure Setpoint

Control Operation Status:  
Drive being controlled via keypad operation or by external run command.

Pump Motor Output Frequency

Transducer Feedback

Drive Status Monitors:  
By using F1 & F2, a user can quickly scroll through drive running statuses, such as, motor amps, motor speed, power consumed, etc.

## Real Time Clock

The iQpump1000 is supported with a real time clock that will log the last 10 fault events with a date and time stamp to provide the pump service technicians with real data for troubleshooting. This feature also enables the user to set calendar run and stop configurations, allowing the system to avoid high utility KW rates during peak day/time/hours.

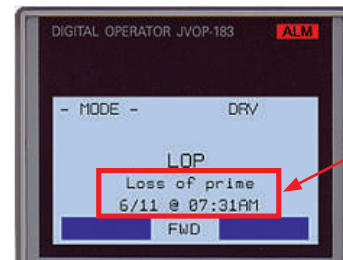

Date & Time Stamp

## Operator Keypad

What makes iQpump1000 the industry standard is the simplicity of the operator keypad messages that are formatted in pump terminology. This informs the user the status of the system operation along with alarms or specific pump algorithm functions that are being initiated.

## Pre-Programmed Application Macros

Pre-programmed applications presets reduce start-up time significantly. Users enter simple motor and application information within the pump quick setup menu for each of the application programs.



## APPLICATION PRESETS:

- ▶ Constant Pressure
- ▶ Pump Down Level Control
- ▶ Geothermal Control
- ▶ Vertical Turbine Pump Pressure Control (VTC)
- ▶ General Purpose Mode
- ▶ Submersible Motor General Purpose, Operator Control

## Options

Enjoy a significant amount of standard control points. The iQpump1000 can also expand to support popular communication networks.

### Standard I/O

- (8) Digital Inputs
- (3) Analog Inputs
- (1) Pulse Input
- Drive Fault Form C Relay
- (3) Programmable Digital Outputs
  - (1) Form C Relay
  - (2) Form A Relays
  - (2) Programmable Analog Outputs
- RS485 Modbus RTU Communication



## Communication Network Options

### Industrial Communication

- Modbus RTU (built-in)
- DeviceNet
- EtherNet/IP
- Modbus TCP/IP
- PROFIBUS-DP
- PROFINET

### Building Automation Networks (BAS)

- BACnet
- Lonworks
- Metasys (N2)
- Apogee (P1)

### Expansion I/O Capability

- Analog Output Module (AO-A3)
- Digital Output Module (DO-A3)

## Parameter Conversion Mobile App



Web app for product conversion of existing iQpump parameter settings to the new iQpump1000 with *Save Function* to recall modified parameters when cell service is not available. Available for IOS, Android, Windows Mobile, and Kindle Fire platforms.

## Typical Pump Energy Consumption/Savings

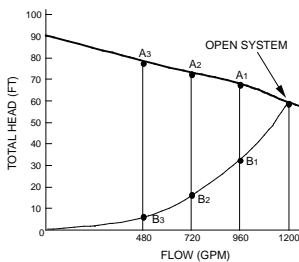

Comparison of Operating Points for Throttling (A) and Adjustable Speed (B) Flow Control.

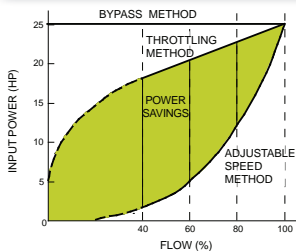

Typical power requirements and savings for throttling and bypass methods to adjustable speed method.

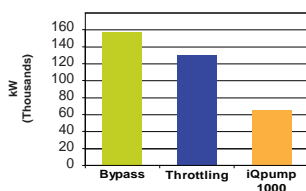

100,000 sq. ft. building operated 4000 hrs/year. (One 50 HP booster pump). Based on Energy Savings Predictor iQpump1000 Software.

## PC SCADA

Troubleshooting, Monitoring, Startup Wizard, Programming, and Trending.



## Utility Harmonics Estimator

Estimation of harmonics contribution back to main power source.

## Energy Savings Predictor

Analysis of energy savings with carbon footprint calculation.

# Protection

## Pump Fault and Alarms

iQpump1000 provides a comprehensive set of pump related alarms and faults. Faults are displayed on the keypad in clear text to eliminate confusion (the following is just a sample):

- Over Cycling
- Transducer Feedback Lost
- Set Point Not Met (Broken Pipe Detection)
- No Flow
- Over Torque
- Low and High Feedback Detection
- Loss of Prime (Dry Well)
- Pumping Over Cycle

## iQpump1000 Drive Protection

- Over / Under Voltage
- Short Circuit
- Input Phase Loss
- Over Temperature
- Phase Imbalance
- Heatsink Fan Failure

## Motor Protection

- Output Phase Loss
- Motor Over Temperature
- Hard Current Limit
- Ground Fault
- Broken Shaft
- Motor Overload
- Minimum Speed

# Why use Single-Phase

## UL Tested and Approved for use on Single-Phase Power

In rural areas or commercial office buildings that were not originally designed to support heavy manufacturing, utilities do not install three-phase power because the cost is significantly more than single-phase power. For many years, people have been using different technology to generate three-phase power from single-phase power sources. Common technologies include rotary-phase converters, static-phase converters, and variable frequency drives. As initial investment costs of variable frequency drives have dropped, more users are turning to iQpump1000 as the best solution to convert single-phase pump motor applications to three-phase.

## Benefits of Three-Phase over Single-Phase Motors

1. Three-phase motors are more compact and less costly than a single-phase motor of the same voltage class and HP (kW) rating.
2. Single-phase AC motors above 10 HP (7.5 kW) are not as efficient and are not usually manufactured in large quantity.
3. Three-phase motors have better starting torque, run more efficiently (i.e. 90% compared to 70%), and last much longer than their single-phase counterparts.
4. iQpump1000 provides motor protection while increasing efficiency and reducing system cost.
5. Reduced motor cable sizes equal lower cost for long motor runs.

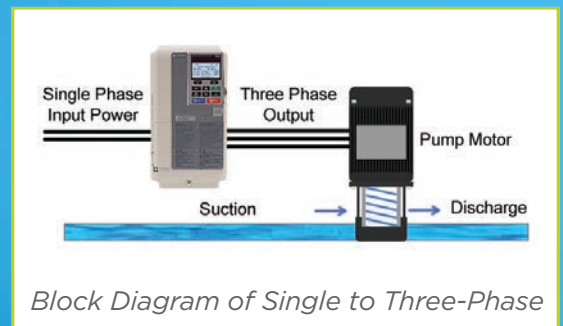

*Note: When sizing iQpump1000 for single to three-phase power conversion, consult your local Yaskawa Representative.*

# Packages for any Environment



**UL Type 3R Packages**

Yaskawa offers pre-engineered configured packages for NEMA 3R, NEMA 12, and NEMA 1 applications. Bypass options are also available, allowing iQpump1000 to address a variety of environmental conditions. Other severe duty, engineered packages, are available upon request.

## **NEMA 3R Specifications:**

Our NEMA 3R configured drive is the most popular and versatile solution for outdoor applications. It combines environmental protection and cost effectiveness in a robust package.

## **Standard Features include:**

- 12 Gauge Steel Construction
- Padlock Hasp
- Integral ¼ Turn Door Latches
- Whole Door Gasket
- Brass Hinges
- UV / Type 3R Keypad Membrane
- Lifting Eyebolts
- Stainless Steel Hardware
- Sun Reflective White Powder Coat Paint

When vertical surfaces are limited, optional leg kits are available for the Type 3R Package to become a freestanding installation. An optional 12" Leg Kit or 30" Leg Kit is available.

## **The following are Type 3R package options:**

- CSA, UL and cUL Rated.
- Service Entrance Rated Disconnect.
- Space Heater with Thermostat - maintains the internal cabinet temperature to reduce condensation.
- NEC branch circuit protection device for input power with flange-mounted operating handle.
- Surge Suppressor - adds a degree of protection to the Type 3R Package from transient surges coming through the power line cables. Lightning strikes are the most common source of surges.
- Custom Engraved Nameplates - white lettering on black background is available.
- Drive Keypad Viewing Window - the drive keypad viewing window is mounted on the outside of the Type 3R Package door. This option provides a viewing window which is hinged and lockable.
- Factory mounted configured power/control options, such as: circuit breaker, fuses, line/load reactors, RFI filter, 3-contactor bypass, and network communications.

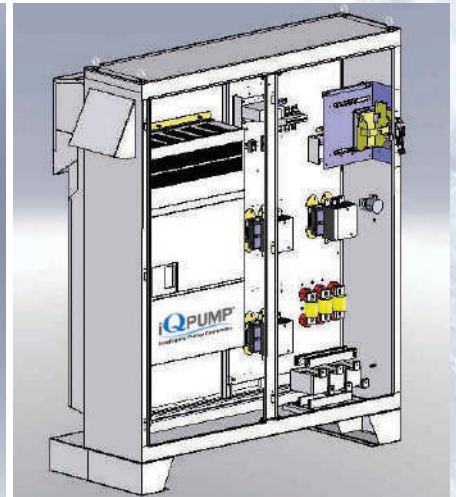
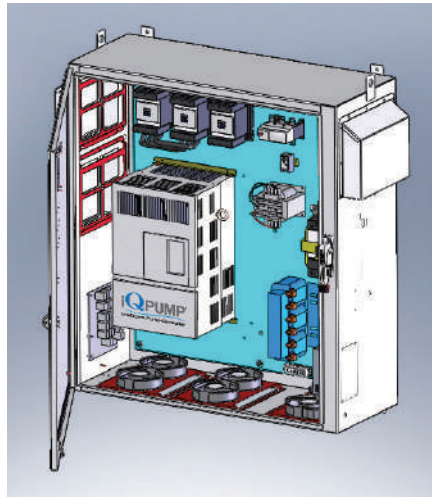



# Simplex Pump System

## Overview

The most common applications are simplex (single pump) constant pressure and pump down level control. The iQpump1000 is an easy investment choice with preset application macros, dedicated pump control features, and pump system protection.

## Examples of Simplex Systems

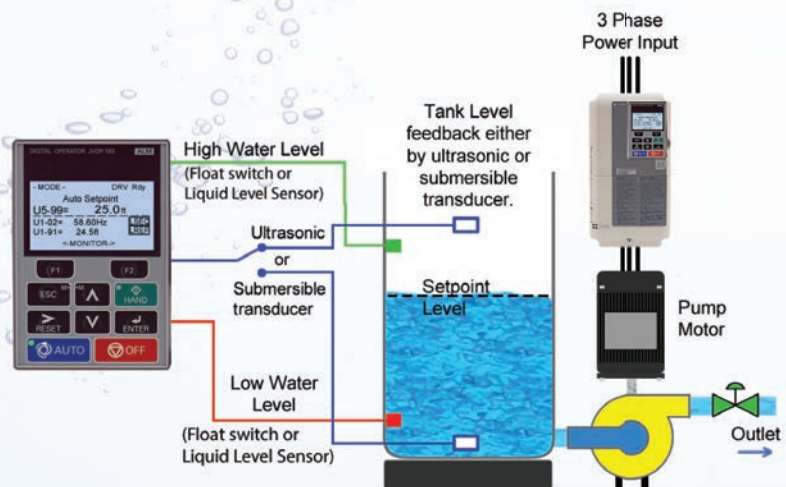
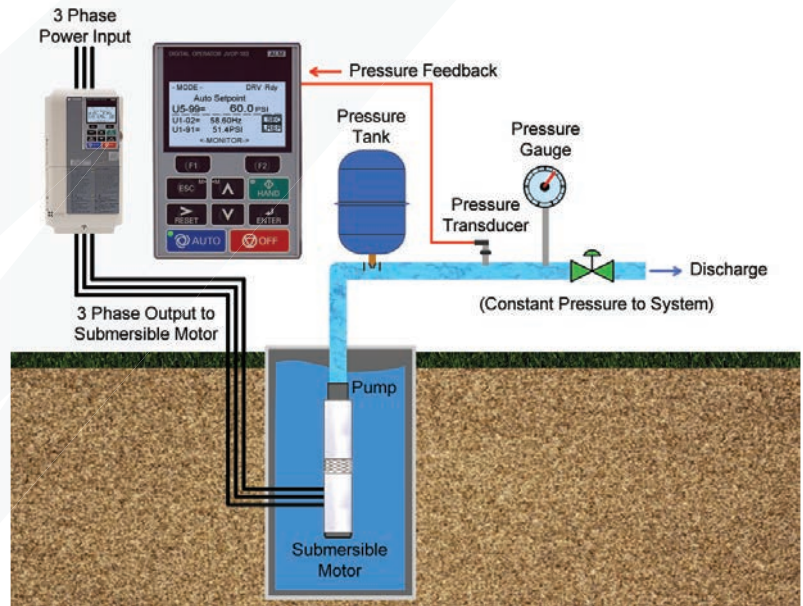

### APPLICATION REQUIREMENTS

- ▶ Sleep Mode Minimum Flow Protection
- ▶ No Flow / Deadhead Protection
- ▶ Submersible Motor Thrust Bearing Control
- ▶ Automatic System Restart
- ▶ Sleep Boost
- ▶ Low and High Pressure Feedback Detection
- ▶ Impeller Anti-jam Protection
- ▶ Constant Pressure with Well Drawn Down Control
- ▶ Power Loss Utility Start Delay Timer
- ▶ Loss of Prime (LOP) / Pump Dry-Run Protection
- ▶ Pre-Charge Control (Controlled Pipe Fill)
- ▶ Optional Dual Transducer Feedback for Redundancy
- ▶ Impeller De-scaling / De-ragging Control

# Software Features

## **Sleep Mode Minimum Flow Protection**

Protects and shuts down the pump at low speeds or in low flow conditions.

## **No Flow / Deadhead Protection**

Detects changes in pressure and flow when the system has been closed off via mechanical valves or restrictions. If a system is not protected from this condition, the water within the pump can vaporize, building up excessive heat, that can damage the pump and the discharge piping.

## **Submersible Motor Thrust Bearing Control**

Protects the bearings of submersible pump motors by ensuring proper start-up speeds and times.

## **Automatic System Restart**

Programmable timers allow iQpump1000 to automatically restart the system in Auto Mode for faults relating to brown outs, loss of power, and pump specific faults.

## **Sleep Boost**

Intended for use with a pressure tank, iQpump1000 boosts the set pressure prior to shutdown, extending the pump's sleep time, reducing cycling, and saving energy.

## **Low and High Pressure Feedback Detection**

iQpump1000 continuously monitors the system feedback device to provide a warning alarm or fault based on the programmed level.

## **Impeller Anti-Jam Automatic Control**

Provides a method for the iQpump1000 to detect high current and attempt to expel corrosion or solids which are impeding the pump impeller. The system will perform a quick reversal to try and dislodge a jam.

## **Constant Pressure with Well Draw Down Control**

This function allows iQpump1000 to control constant pressure when there is adequate water in the well, while monitoring a second down hole transducer for water level. If the water level drops below user settings, iQpump1000 reduces pump speed to maximize well output. System will return automatically to normal operation when well water is recharged to an adequate level.

## **Power Loss Utility Start Delay Timer**

Used in conjunction with "Automatic Restart", a programmable timer will delay starting to allow for multiple pumps to sequence start on loss of power. This function ensures that the power system is not stressed when utility power has returned and pump system is automatically restarted.

## **Loss of Prime (LOP) / Pump Dry-Run Protection**

Loss of prime protection is a feature to protect the pump and motor from damage caused by running the pump without water. If a pump were to lose prime and continue to operate without water moving through the pump, the pump would develop heat, which would eventually damage the pump seal, motor, pipe manifold and related components.

## **Pre-Charge Control (Controlled Pipe Fill)**

This programmable feature eliminates water hammer and extends system life by gradually filling a pipeline before normal full pressure and flow operation. Pump motor speed can be controlled with a system timer, level or pressure control device to indicate when normal operation may begin.

## **Secondary Transducer Backup**

This option used for Simplex control allows for a secondary backup transducer to be automatically used if the main transducer has failed. Keypad text message will alert what feedback transducer is being used.



***20 HP Submersible Pump Control  
for Irrigation.***

# Drive with Constant Speed Lag Pump Multiplexing

## Overview

Many agricultural farms use multiple large verticle turbine pumps to provide pressurized water to large pivot irrigation systems. Applying a VFD to each of the booster pumps on these systems may not be practical. However, iQpump1000, using it's on-board digital outputs, can control up to 5 lag pump starters from a single VFD to maintain pressure by staging and de-staging the lag pumps.

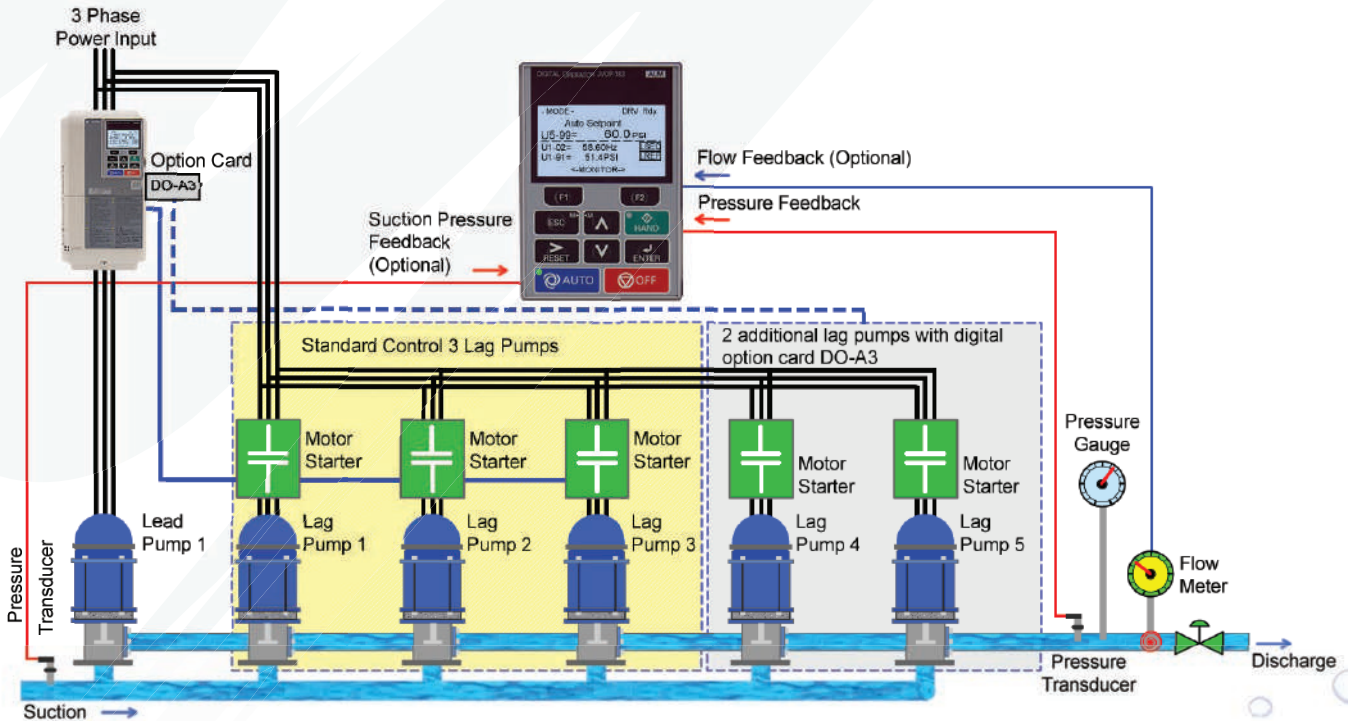

## APPLICATION REQUIREMENTS

- ▶ Inlet Suction Control
- ▶ Speed Reduction "Go To Speed" After Lag Pump Staging
- ▶ Setpoint Boost After De-staging
- ▶ Low Flow and High Flow (GPM) Protection
- ▶ Flow Meter Data Logging
- ▶ Lube Pump Control
- ▶ Hard Current Limit
- ▶ Back Spin Timer
- ▶ High Discharge Pressure Lag Pump Quick de-Staging

## Application Notes

- Automatically starts and stops up to 5 Lag pumps based on the system demand, and will automatically stage and de-stage the booster pumps.
- Alternation of lag pumps to provide even wear.
- Allows a single lag pump to be selected during Pre-Charge (Pipe-Fill) to reduce fill rate time.
- For large water consumers, acre-feet can be selected for water accumulation units.
- When the discharge pressure exceeds a high level setting, all running lag pumps will be quickly de-staged to prevent unsafe high pressure conditions.
- When using Pre-Charge, Lag Pump Staging and De-Staging functions, the drive's keypad will provide a message of time remaining before pre-charge is finished and/or time remaining before lag pumps are to stage and de-stage.



# Software Features

## Inlet Suction Control

iQpump1000, when installed with an inlet suction transducer, will monitor a suction pressure drop to a programmed suction pressure setpoint. The iQpump1000 seamlessly switches over and controls suction pressure to keep the system running efficiently. If the inlet pressure returns to the suction pressure setpoint at anytime, the iQpump1000 will switch back to controlling outlet pressure. A suction pressure alarm/fault detection is available if the suction pressure drops below the Low Suction Pressure Detection Level for more than the Low Suction Pressure Detection Time.

## Speed Reduction “Go To Speed” After Lag Pump Staging

This feature will force the lead iQpump1000, when in VTC mode, to operate at a lower fixed speed for a specified amount of time whenever a lag pump is staged on. This is to dampen the shock loading of a lag pump starting across the line to the system.

## Setpoint Boost After De-staging

This feature will automatically boost the auto setpoint pressure to a new specified incremental amount for a programmable time whenever a pump is de-staged. This allows the lead iQpump1000, when in VTC mode, to accelerate more quickly to lessen the pressure drop on the system of a lag pump that is being de-staged.

## Low Flow and High Flow (GPM) Protection

iQpump1000 continuously monitors the system flow signal feedback to provide a warning alarm or fault based on the programmed level.

## Flow Meter Data Logging

Through a secondary analog or pulse train input, a flow sensor can be connected inline with the pump system back to iQpump1000 to read and accumulate total system flow to report to authorities. The system can be configured to detect “No Flow” and switch to “Sleep” on low demand.

## Lube Pump Control

Designed for pumps that require pre-lubrication before each start. Digital output will energize a solenoid valve for a programmable time before starting, allowing for lubrication each time the pump is started.

## Hard Current Limit

As the pump impeller wears over time, it changes the efficiency of the pump. Therefore, in order to maintain a constant pressure or flow, the pump speed will increase, resulting in greater motor current. This increase can cause the drive to trip on nuisance motor overload (OL). By setting in a hard motor current limit (not to exceed), the drive will reduce the output speed automatically to keep the system running smoothly as the impeller wears to keep the system from overloading.

## Back Spin Timer

After Stop or Hand command, the drive will not restart until timer expires, allowing the water column to flow back down the well.

## High Feedback Quick De-Stage

This feature will quickly de-stage a lag pump if the system feedback reaches a programmable level.



*Quadplex River Booster System.*

# Drive to Drive Multiplexing

## Overview

iQpump1000 has enhanced software not available in standard variable frequency drives, allowing for multiple drives to operate as a coordinated system. This allows pump system engineers the ability to add more modular pump systems together (Duplex, Triplex, etc.) to meet customer specifications and minimize cost by eliminating external control via PLC's and HMI's.

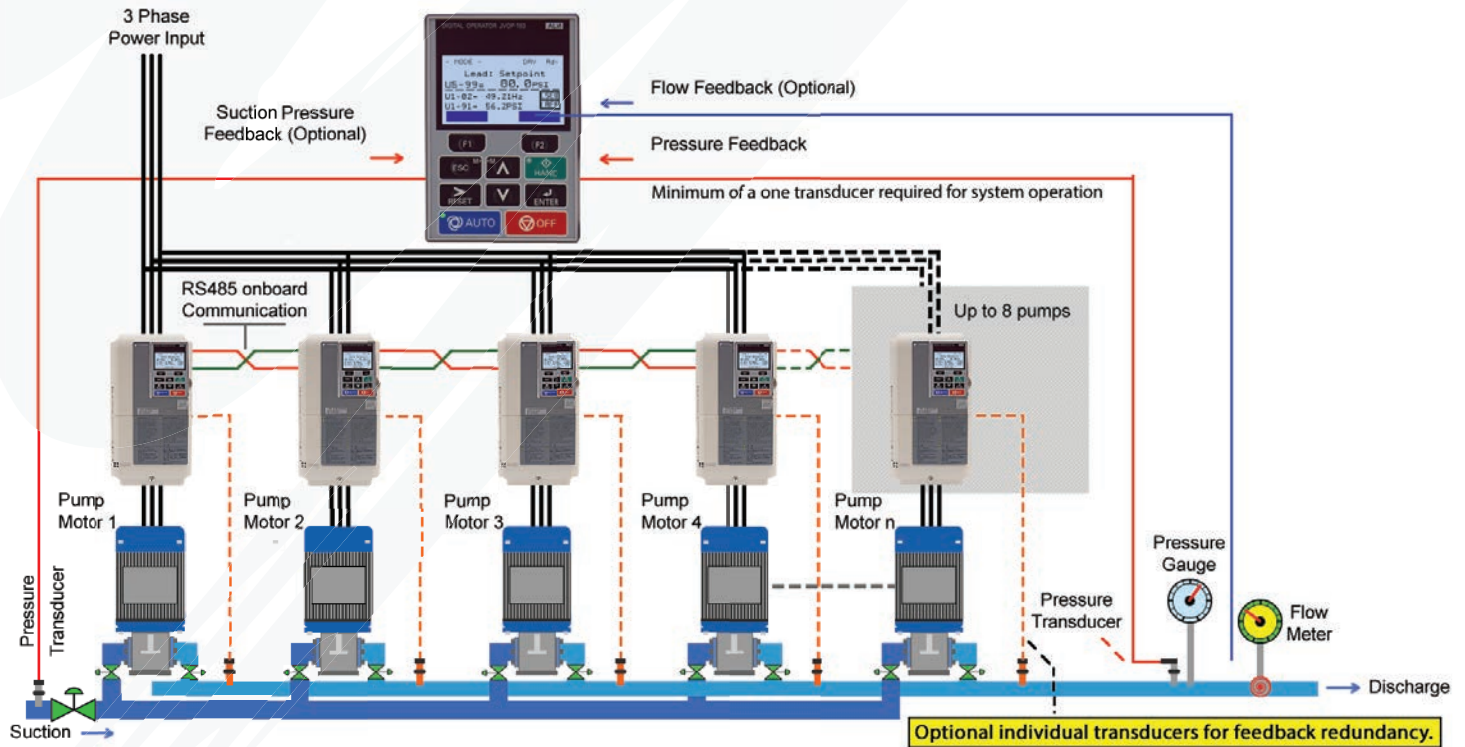

## APPLICATION REQUIREMENTS

- ▶ Pump Alternation
- ▶ Pump and Drive Redundancy
- ▶ Transducer Feedback Redundancy
- ▶ Pump Run Priority Selection
- ▶ Jockey Pump Control
- ▶ Pump Stage and De-Stage
- ▶ Lag Pump Lead Speed Follower Mode

## Application Notes

- Automatically alternates all pumps with a system programmable timer to provide even mechanical pump wear.
- Configurable transducer feedback settings to provide redundant backup if failure occurs.
- With the use of an optional suction transducer, all iQpump1000's will monitor inlet pressure with programmable PSI settings for faults, alarms and station controlled shutdown.
- Digital switch inputs for Low Suction / Low City Pressure / Low Water in Break Tank can be configured with selectable keypad message to match application.
- With the use of an optional flow input, all iQpump1000's can be configured to control staging and de-staging of lag pumps on GPM.

# Software Features

## Pump Alternation

Whether it's a duplex or a quadplex system, the pumps will be exercised evenly to ensure that they receive equal run times, thereby increasing the life cycle of the pumps and motors.

## Pump and Drive Redundancy

If a drive or pump fails during operation or is taken out of service for maintenance, the remaining pumps continue to operate. The other drives on the network will automatically recognize when the drive and pump are restored to active healthy status and put them back into the pump rotation.

## Transducer Feedback Redundancy

Systems can be configured using multiple transducers on the discharge allowing for redundancy. A minimum of one transducer is required for system operation.

## Jockey Pump Control

Pressure booster systems that use a jockey pump to maintain minimum water flow with larger secondary booster pumps for peak demands require the jockey pump to always be defined as the lead pump. The larger booster pumps will alternate based on time or run cycle for even pump wear.

## Pump Stage and De-Stage

System dynamics and pump curves will determine the best method of pump staging and de-staging. The user can select a variety of methods such as: Pump Output Speed, Pressure Differential to Setpoint, Combination of Output Speed and Differential Pressure, and Flow Rate using an in-line flow meter.

## Lag Pump Lead Speed Follower Mode

When enabled, all lag iQpump1000 drives will follow the main output speed (Hz or RPM) of the lead iQpump, thereby allowing all lead and lag pumps to run at the same speed for better system efficiency.



*Triplex Booster System for New Jersey Hospital*

## Typical Multiplex Keypad Messages

The iQpump1000 Keypad will provide the user with all the necessary system status operation and pump fault messages to ensure that service operators can efficiently monitor and diagnose any condition.

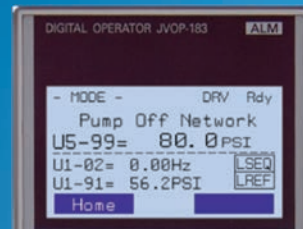

iQpump1000 is in Off Mode (stopped) and has not been given an Auto Run command. Drive is taken out of the running queue.

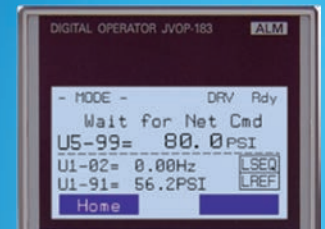

iQpump1000 is in Auto Mode and waiting for a run command from the network.

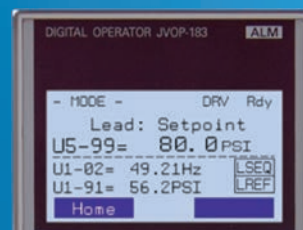

iQpump1000 is in Auto Mode and is the Lead pump.



iQpump1000 is in Auto Mode and when a new Lead pump is staged, the Lag pump will be locked at a fixed speed.

# Model Number Designation

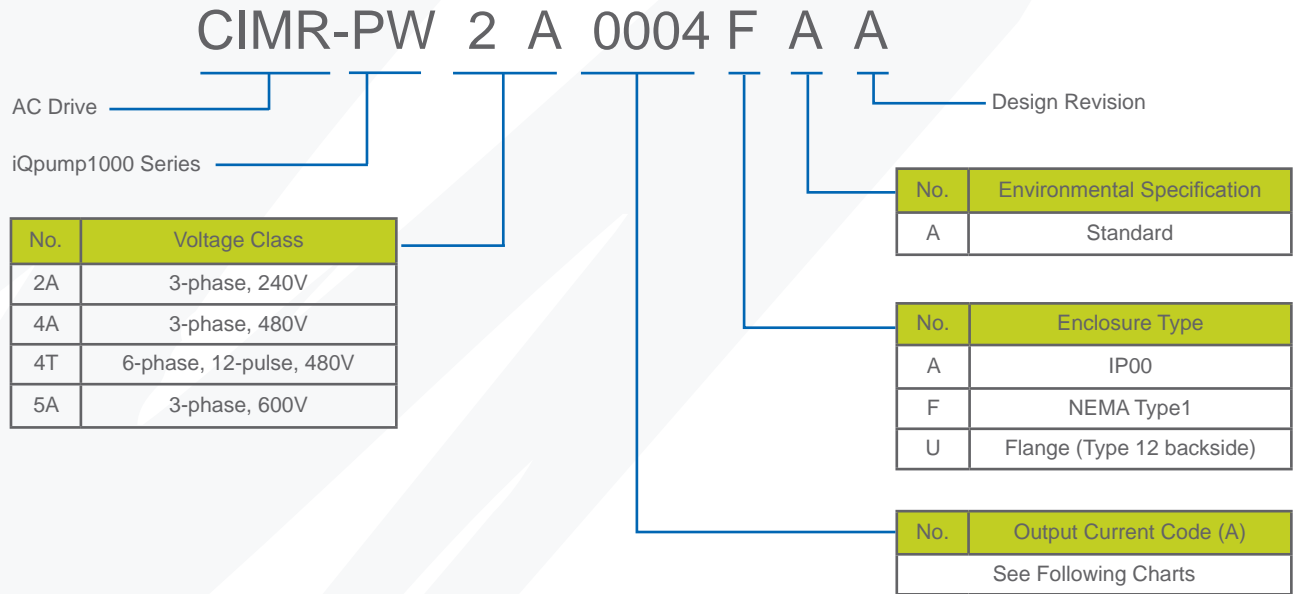

## Drive Ratings - 240V

240V, 3-Phase Input			
Rated Output Amps	Nominal HP	Model Number CIMR-PW	Variant F = NEMA 1 A = Protected Chassis (IP00) U = Flange (NEMA 12 Backside)
3.5	3/4	2A0004_AA	F, U
6	1	2A0006_AA	F, U
8	2	2A0008_AA	F, U
9.6	3	2A0010_AA	F, U
12	3	2A0012_AA	F, U
17.5	5	2A0018_AA	F, U
21	7.5	2A0021_AA	F, U
30	10	2A0030_AA	F, U
40	15	2A0040_AA	F, U
56	20	2A0056_AA	F, U
69	25	2A0069_AA	F, U
81	30	2A0081_AA	F, U
110	40	2A0110_AA	F, U
138	50	2A0138_AA	F, U
169	60	2A0169_AA	F, U
211	75	2A0211_AA	F, U
250	100	2A0250_AA	A, U
312	125	2A0312_AA	A, U
360	150	2A0360_AA	A, U
415	175	2A0415_AA	A, U

240V, 1-Phase Input 208-230V Three-Phase Output							
Single Phase Input - Size Method A <sup>(A)</sup> (continuous full power)				Single Phase Input - Sizing Method B <sup>(B)</sup> (86% max power of connected motor size)		Model Number CIMR-PW	Variant F = NEMA 1 A = Protected Chassis (IP00) U = Flange (NEMA 12 Backside)
Without Additional Reactor		With Additional Reactor		Motor Amps	Motor Size (HP)		
Motor Amps	Motor Size (HP)	Motor Amps	Motor Size (HP)				
1.7	1/3	2.4	1/2	2.4	1/2	2A0004_AA	F, U
3.5	3/4	3.5	3/4	4.6	1	2A0006_AA	F, U
4.6	1	4.6	1	4.6	1	2A0008_AA	F, U
4.6	1	4.6	1	6.6	1.5	2A0010_AA	F, U
6.6	1.5	7.5	2	7.5	2	2A0012_AA	F, U
7.5	2	10.6	3	10.6	3	2A0018_AA	F, U
7.5	2	10.6	3	10.6	3	2A0021_AA	F, U
10.6	3	10.6	3	17	5	2A0030_AA	F, U
10.6	3	17	5	17	5	2A0040_AA	F, U
17	5	24	7.5	24	7.5	2A0056_AA	F, U
24	7.5	31	10	31	10	2A0069_AA	F, U
31	10	46	15	46	15	2A0081_AA	F, U
31	10	31	10	46	15	2A0110_AA	F, U
46	15	46	15	59	20	2A0138_AA	F, U
59	20	59	20	75	25	2A0169_AA	F, U
75	25	75	25	88	30	2A0211_AA	F, U
88	30	88	30	114	40	2A0250_AA	A, U
114	40	114	40	143	50	2A0312_AA	A, U
143	50	143	50	169	60	2A0360_AA	A, U
169	60	169	60	211	75	2A0415_AA	A, U

(A) Use single phase sizing method A for applications requiring more than 87% motor power (more than 95% speed for variable torque) for any length of time.

(B) Use single phase sizing method B for applications requiring no more than 87% motor power (no more than 95% speed for variable torque).

# Drive Ratings - 480V

480V, 3-Phase Input			
Rated Output Amps	Nominal HP	Model Number CIMR-PW	Variant F = NEMA 1
			A = Protected Chassis (IP00)  U = Flange (NEMA 12 Backside)
2.1	1	4A0002_AA	F, U
4.1	2	4A0004_AA	F, U
5.4	3	4A0005_AA	F, U
6.9	4	4A0007_AA	F, U
8.8	5	4A0009_AA	F, U
11.1	7.5	4A0011_AA	F, U
17.5	10	4A0018_AA	F, U
23	15	4A0023_AA	F, U
31	20	4A0031_AA	F, U
38	25	4A0038_AA	F, U
44	30	4A0044_AA	F, U
58	40	4A0058_AA	F, U
72	50	4A0072_AA	F, U
88	60	4A0088_AA	F, U
103	75	4A0103_AA	F, U
139	100	4A0139_AA	F, U
165	125	4A0165_AA	F, U
208	150	4A0208_AA	A, U
250	200	4A0250_AA	A, U
296	250	4A0296_AA	A, U
362	300	4A0362_AA	A, U
414	350	4A0414_AA	A, U
515	400	4A0515_AA	A, U
675	500 - 550	4A0675_AA	A, U
930	600 - 800	4A0930_AA	A, U
1200	900 - 1000	4A1200_AA	A, U

480V, 1-Phase Input 460V Three-Phase Output							
Single Phase Input - Size Method A <sup>(A)</sup> (continuous full power)				Single Phase Input - Sizing Method B <sup>(B)</sup> (86% max power of connected motor size)		Model Number CIMR-PW	Variant F = NEMA 1 A = Protected Chassis (IP00)  U = Flange (NEMA 12 Backside)
Without Additional Reactor		With Additional Reactor		Motor Amps	Motor Size (HP)		
Motor Amps	Motor Size (HP)	Motor Amps	Motor Size (HP)			Motor Amps	Motor Size (HP)
0.8	1/3	1.1	1/2	0.8	1/3	4A0002_AA	F, U
1.6	3/4	2.1	1	2.1	1	4A0004_AA	F, U
2.1	1	3	1.5	3	1.5	4A0005_AA	F, U
3.0	1.5	3.4	2	3.4	2	4A0007_AA	F, U
3.4	2	4.8	3	4.8	3	4A0009_AA	F, U
3.4	2	4.8	3	4.8	3	4A0011_AA	F, U
4.8	3	4.8	3	7.6	5	4A0018_AA	F, U
4.8	3	7.6	5	7.6	5	4A0023_AA	F, U
11	7.5	11	7.5	14	10	4A0031_AA	F, U
11	7.5	14	10	14	10	4A0038_AA	F, U
14	10	14	10	21	15	4A0044_AA	F, U
21	15	21	15	27	20	4A0058_AA	F, U
27	20	27	20	34	25	4A0072_AA	F, U
27	20	27	20	34	25	4A0088_AA	F, U
27	20	27	20	34	25	4A0103_AA	F, U
52	40	52	40	65	50	4A0139_AA	F, U
52	40	52	40	65	50	4A0165_AA	F, U
65	50	65	50	77	60	4A0208_AA	A, U
77	60	77	60	96	75	4A0250_AA	A, U
96	60	96	75	124	100	4A0296_AA	A, U
124	75	124	100	156	125	4A0362_AA	A, U
156	125	156	125	180	150	4A0414_AA UUX000861 <sup>(C)</sup>	A, U
156	125	156	125	180	150	4A0515_AA UUX000862 <sup>(C)</sup>	A, U
180	150	180	150	240	200	4A0675_AA UUX000863 <sup>(C)</sup>	A, U

(A) Use single phase sizing method A for applications requiring more than 87% motor power (more than 95% speed for variable torque) for any length of time.

(B) Use single phase sizing method B for applications requiring no more than 87% motor power (no more than 95% speed for variable torque).

(C) NEMA 1 Compatible.

480V, 12-Pulse			
Rated Output Amps	Nominal HP	Model Number CIMR-PW	Variant U = Flange (NEMA 12 Backside)
			58
72	50	4T0072_AA	U
88	60	4T0088_AA	U
103	75	4T0103_AA	U
139	100	4T0139_AA	U
165	125	4T0165_AA	U
208	150	4T0208_AA	U
250	200	4T0250_AA	U
296	250	4T0296_AA	U
362	300	4T0362_AA	U
414	350	4T0414_AA	U
515	400	4T0515_AA	U
675	500 - 550	4T0675_AA	U



# Drive Ratings - 600V

600V, 3-Phase Input			
Rated Output Amps	Nominal HP	Model Number CIMR-PW	Variant F = NEMA 1
			A = Protected Chassis (IP00)  U = Flange (NEMA 12 Backside)
2.7	1 & 2	5A0003_AA	F, U
3.9	3	5A0004_AA	F, U
6.1	5	5A0006_AA	F, U
9	7.5	5A0009_AA	F, U
11	10	5A0011_AA	F, U
17.5	15	5A0017_AA	F, U
22	20	5A0022_AA	F, U
27	25	5A0027_AA	F, U
32	30	5A0032_AA	F, U
41	40	5A0041_AA	F, U
52	50	5A0052_AA	F, U
62	60	5A0062_AA	F, U
77	75	5A0077_AA	F, U
99	100	5A0099_AA	F, U
125	125	5A0125_AA	A, U
145	150	5A0145_AA	A, U
192	200	5A0192_AA	A, U

600V, 1-Phase Input 575V Three-Phase Output							
Single Phase Input - Size Method A <sup>(A)</sup> (continuous full power)				Single Phase Input - Sizing Method B <sup>(B)</sup> (86% max power of connected motor size)		Model Number CIMR-PW	Variant F = NEMA 1 A = Protected Chassis (IP00)  U = Flange (NEMA 12 Backside)
Without Additional Reactor		With Additional Reactor		Motor Amps	Motor Size (HP)		
Motor Amps	Motor Size (HP)	Motor Amps	Motor Size (HP)			Motor Amps	Motor Size (HP)
1.7	1	2.4	1.5	1.7	1	5A0003_AA	F, U
2.4	1.5	2.7	2	2.7	2	5A0004_AA	F, U
2.7	2	3.9	3	3.9	3	5A0006_AA	F, U
3.9	3	6.1	5	6.1	5	5A0009_AA	F, U
2.7	2	3.9	3	3.9	3	5A0011_AA	F, U
6.1	5	6.1	5	9	7.5	5A0017_AA	F, U
6.1	5	9	7.5	9	7.5	5A0022_AA	F, U
9	7.5	11	10	11	10	5A0027_AA	F, U
9	7.5	11	10	11	10	5A0032_AA	F, U
17	15	17	15	22	20	5A0041_AA	F, U
17	15	17	15	22	20	5A0052_AA	F, U
27	25	27	25	32	30	5A0062_AA	F, U
27	30	32	30	41	40	5A0077_AA	F, U
32	30	32	30	41	40	5A0099_AA	F, U
52	50	52	50	62	60	5A0125_AA	A, U
52	50	52	50	62	60	5A0145_AA	A, U
77	75	77	75	99	100	5A0192_AA	A, U
77	75	77	75	99	100	5A0242_AA	A, U

(A) Use single phase sizing method A for applications requiring more than 87% motor power (more than 95% speed for variable torque) for any length of time.

(B) Use single phase sizing method B for applications requiring no more than 87% motor power (no more than 95% speed for variable torque).

# Mechanical Installation Planning

## Drive Dimensions

### NEMA Type 1 [IP20] Diagram

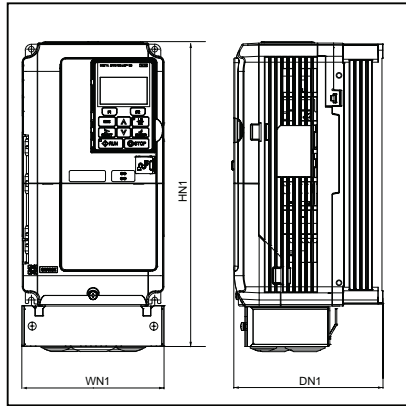

*iQpump1000 with NEMA Type 1 Kit Installed*

### Protected Chassis/External Heatsink Diagram

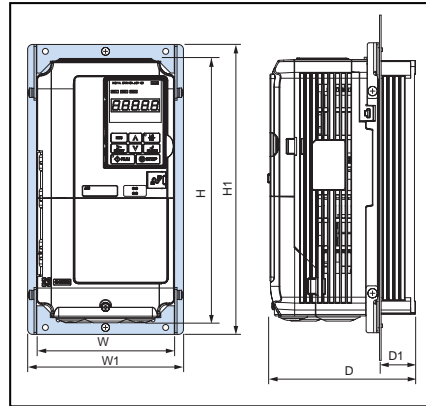

*iQpump1000 Protected Chassis / External Heatsink Configuration*

#### Notes:

1. The diagrams shown are simplified dimensional diagrams designed to display key outer dimensions of the drive. They are meant for planning purposes only. For more detailed dimensional/mounting data, please refer to the iQpump1000 dimensional drawings on [www.yaskawa.com](http://www.yaskawa.com)
2. Drives with NEMA Type 1 Enclosures can be converted to protected chassis by removing the top and bottom covers.
3. When mounting standard drives with heatsink external (NEMA 1 backside), the following models require a separately sold bracket kit: CIMR-PW2A0004Fxx to 0081Fxx, CIMR-PW4A0002Fxx to 0044Fxx, and CIMR-PW5A0003Fxx to 0032Fxx.

Larger standard drives include brackets that must be detached from the back and reattached at the midpoint.

### 240V Class

Model CIMR-PW2A □□□□	Frame Size	Max. Applicable Motor Capacity (HP)	Dimensions (in.)									Weight (lb)	
			WN1	W	W1	HN1	H	H1	DN1	D	D1	NEMA 1	Protected Chassis
0004	1	0.75	5.51	5.51	7.64	12.06	10.24	11.81	5.79	5.79	1.34	7.3	--
0006		1.5	5.51	5.51	7.64	12.06	10.24	11.81	5.79	5.79	1.34	7.3	--
0008		2	5.51	5.51	7.64	12.06	10.24	11.81	5.79	5.79	1.34	7.5	--
0010		3	5.51	5.51	7.64	12.06	10.24	11.81	5.79	5.79	1.34	7.5	--
0012		3	5.51	5.51	7.64	12.06	10.24	11.81	5.79	5.79	1.34	7.5	--
0018	2	5	5.51	5.51	7.64	12.06	10.24	11.81	6.46	6.46	2.06	8.2	--
0021		7.5	5.51	5.51	7.64	12.06	10.24	11.81	6.46	6.46	2.06	8.2	--
0030	3	10	5.51	5.51	7.64	12.06	10.24	11.81	6.57	6.57	2.07	9.3	--
0040		15	5.51	5.51	7.64	12.06	10.24	11.81	6.57	6.57	2.07	9.3	--
0056	5	20	7.09	7.09	9.21	13.38	11.81	13.39	7.36	7.36	2.83	13.0	--
0069	6	25	8.66	8.66	11.65	15.47	13.78	16.54	7.76	7.76	2.91	20.1	--
0081		30	8.66	8.66	11.65	15.47	13.78	16.54	7.76	7.76	2.91	22.0	--
0110	7A	40	10.00	10.00	12.13	21.37	15.75	16.3	10.16	10.16	3.82	50.7	46.2
0138	8A	50	10.98	10.98	12.99	24.52	17.72	18.11	10.16	10.16	3.81	61.7	55.0
0169	10	60	12.95	12.95	15.2	30.08	21.65	22.13	11.14	11.14	4.21	90.2	81.4
0211		75	12.95	12.95	15.2	30.08	21.65	22.13	11.14	11.14	4.21	92.4	83.6
0250	11	100	17.95	17.72	22.05	37.80	27.76	28.54	12.99	12.99	5	191.8	167.6
0312		125	17.95	17.72	22.05	37.80	27.76	28.54	12.99	12.99	5	191.8	176.4
0360	12	150	19.84	19.69	23.62	45.98	31.50	32.28	13.78	13.78	5	233.7	216.1
0415		175	19.84	19.69	23.62	45.98	31.50	32.28	13.78	13.78	5	233.7	218.3

# Mechanical Installation Planning

## 480V Class

Model CIMR-PW4A □□□□	Frame Size	Max. Applicable Motor Capacity (HP)	Dimensions (in.)									Weight (lb)	
			WN1	W	W1	HN1	H	H1	DN1	D	D1	NEMA 1	Protected Chassis
0002	1	1	5.51	5.51	7.64	12.06	10.24	11.81	5.79	5.79	1.34	7.3	--
0004		2	5.51	5.51	7.64	12.06	10.24	11.81	5.79	5.79	1.34	7.3	--
0005		3	5.51	5.51	7.64	12.06	10.24	11.81	5.79	5.79	1.34	7.3	--
0007	2	3	5.51	5.51	7.64	12.06	10.24	11.81	6.46	6.46	2.06	8.2	--
0009		5	5.51	5.51	7.64	12.06	10.24	11.81	6.46	6.46	2.06	8.2	--
0011		7.5	5.51	5.51	7.64	12.06	10.24	11.81	6.46	6.46	2.06	8.2	--
0018	3	10	5.51	5.51	7.64	12.06	10.24	11.81	6.57	6.57	2.07	9.3	--
0023		15	5.51	5.51	7.64	12.06	10.24	11.81	6.57	6.57	2.07	9.3	--
0031	4	20	7.09	7.09	9.21	13.38	11.81	13.39	6.88	6.88	2.04	12.5	--
0038	5	25	7.09	7.09	9.21	13.38	11.81	13.39	7.36	7.36	2.83	13.0	--
0044	6	30	8.66	8.66	11.65	15.47	13.78	16.54	7.76	7.76	2.91	20.1	--
0058	7B	40	10.37	10.37	12.13	18.65	15.75	16.3	10.16	10.16	3.82	50.6	50.6
0072	8B	50	11.35	11.35	12.99	20.62	17.72	18.11	10.16	10.16	3.81	59.4	59.4
0088	9	60	13.32	13.16	15.35	25.16	20.06	21.34	10.27	10.27	3.97	85.8	79.2
0103		75	13.32	13.16	15.35	25.16	20.06	21.34	10.27	10.27	3.97	85.8	79.2
0139	10	100	12.95	12.95	15.2	30.08	21.65	22.13	11.14	11.14	4.21	99.0	90.2
0165		125	12.95	12.95	15.2	30.08	21.65	22.13	11.14	11.14	4.21	101	92.4
0208	11	150	17.95	17.72	22.05	37.80	27.76	28.54	12.99	12.99	5	191	174
0250	12	200	19.84	19.69	23.62	45.98	31.50	32.28	13.78	13.78	5	233	211
0296		250	19.84	19.69	23.62	45.98	31.50	32.28	13.78	13.78	5	246	224
0362		300	19.84	19.69	23.62	45.98	31.50	32.28	13.78	13.78	5	257	235
0414	13	350	20.29	20.29	25.39	48.3	37.4	40.55	14.68	14.68	5.19	292	275
0515	14	450	26.86	26.86	31.97	61.3	44.88	46.38	14.72	14.72	7.71	504	475
0675		600	26.86	26.86	31.97	61.3	44.88	46.38	14.72	14.72	7.71	515	486
0930	15	800	50.2	49.61	--	80.4	54.33	--	14.73	14.91	--	1394	1195
1200		1000	50.2	49.61	--	80.4	54.33	--	14.73	14.91	--	1420	1221

## 600V Class

Model CIMR-PW5A □□□□□	Frame Size	Max. Applicable Motor Capacity (HP)	Dimensions (in.)									Weight (lb)	
			WN1	W	W1	HN1	H	H1	DN1	D	D1	NEMA 1	Protected Chassis
0003	1	2	5.51	5.51	7.64	12.06	10.24	11.81	5.79	5.79	1.34	7.3	--
0004		3	5.51	5.51	7.64	12.06	10.24	11.81	5.79	5.79	1.34	7.3	--
0006	2	5	5.51	5.51	7.64	12.06	10.24	11.81	6.46	6.46	2.06	8.2	--
0009		7.5	5.51	5.51	7.64	12.06	10.24	11.81	6.46	6.46	2.06	8.2	--
0011	3	10	5.51	5.51	7.64	12.06	10.24	11.81	6.57	6.57	2.07	9.3	--
0017	5	15	7.09	7.09	9.21	13.38	11.81	13.39	7.36	7.36	2.83	13.0	--
0022		20	7.09	7.09	9.21	13.38	11.81	13.39	7.36	7.36	2.83	13.0	--
0027	6	25	8.66	8.66	11.65	15.47	13.78	16.54	7.76	7.76	2.91	20.1	--
0032		30	8.66	8.66	11.65	15.47	13.78	16.54	7.76	7.76	2.91	20.1	--
0041	8B	40	11.35	11.35	12.99	20.62	17.72	18.11	10.16	10.16	3.81	59.4	59.4
0052		50	11.35	11.35	12.99	20.62	17.72	18.11	10.16	10.16	3.81	59.4	59.4
0062	10	60	12.95	12.95	15.2	30.08	21.65	22.13	11.14	11.14	4.21	99.0	90.2
0077		75	12.95	12.95	15.2	30.08	21.65	22.13	11.14	11.14	4.21	99.0	90.2
0099		100	12.95	12.95	15.2	30.08	21.65	22.13	11.14	11.14	4.21	99.0	90.2
0125	11	125	17.95	17.72	22.05	37.80	27.76	28.54	12.99	12.99	5	191	174
0145		150	17.95	17.72	22.05	37.80	27.76	28.54	12.99	12.99	5	191	174
0192	12	200	19.84	19.69	23.62	45.98	31.50	32.28	13.78	13.78	5	233	235
0242		250	19.84	19.69	23.62	45.98	31.50	32.28	13.78	13.78	5	257	235

This page intentionally left blank.

We take quality personally at Yaskawa. Our drives and servo packages offer the highest MTBF in the world. The relationships we have with our customers ensure mutual benefits. The partnerships we cultivate with our distributors add value to the way we work with you. We hire great people and continuously train them to be able to serve your needs better. We deliver product on time. It works out of the box. We answer questions promptly and never say, "we can't."

To us, quality means doing everything we can to make our customer, partner, and employee experiences great.

We commit to that philosophy every day. We make it happen. We can because, to us,  
IT'S PERSONAL.



**Yaskawa America, Inc.**  
Drives & Motion Division

2121 Norman Drive South  
Waukegan, IL 60085

1-800-YASKAWA (927-5292) • Local: 847-887-7000 • Fax: 1-847-887-7310

[DrivesHelpDesk@yaskawa.com](mailto:DrivesHelpDesk@yaskawa.com) • [www.yaskawa.com](http://www.yaskawa.com)

Document BL.iQp1000.01 01/15/14 • © 2014



# Designed with Pump Operators in Mind

Designed with the user in mind, iQpump1000 uses intuitive pump related terminology, with simple process control selection of engineering units such as PSI, GPM, Feet, Metric, Temperature, Inches of Mercury, and many other process control units.

## Pump Specific HOA Operator

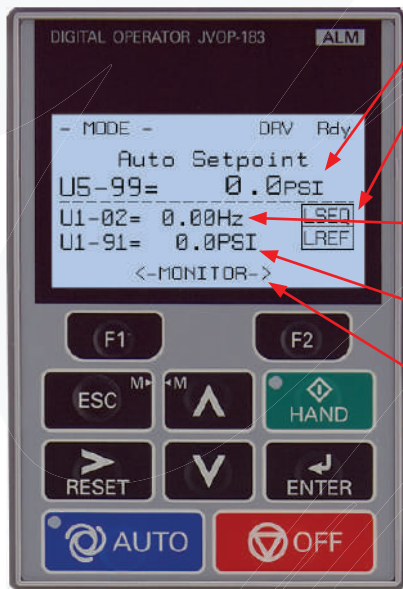

System Pressure Setpoint

Control Operation Status:  
Drive being controlled via keypad operation or by external run command.

Pump Motor Output Frequency

Transducer Feedback

Drive Status Monitors:  
By using F1 & F2, a user can quickly scroll through drive running statuses, such as, motor amps, motor speed, power consumed, etc.

## Real Time Clock

The iQpump1000 is supported with a real time clock that will log the last 10 fault events with a date and time stamp to provide the pump service technicians with real data for troubleshooting. This feature also enables the user to set calendar run and stop configurations, allowing the system to avoid high utility KW rates during peak day/time/hours.

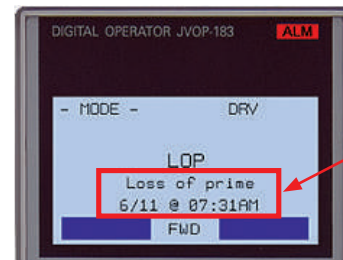

Date & Time Stamp

## Operator Keypad

What makes iQpump1000 the industry standard is the simplicity of the operator keypad messages that are formatted in pump terminology. This informs the user the status of the system operation along with alarms or specific pump algorithm functions that are being initiated.

## Pre-Programmed Application Macros

Pre-programmed applications presets reduce start-up time significantly. Users enter simple motor and application information within the pump quick setup menu for each of the application programs.



## APPLICATION PRESETS:

- ▶ Constant Pressure
- ▶ Pump Down Level Control
- ▶ Geothermal Control
- ▶ Vertical Turbine Pump Pressure Control (VTC)
- ▶ General Purpose Mode
- ▶ Submersible Motor General Purpose, Operator Control

# Simplex Pump System

## Overview

The most common applications are simplex (single pump) constant pressure and pump down level control. The iQpump1000 is an easy investment choice with preset application macros, dedicated pump control features, and pump system protection.

## Examples of Simplex Systems

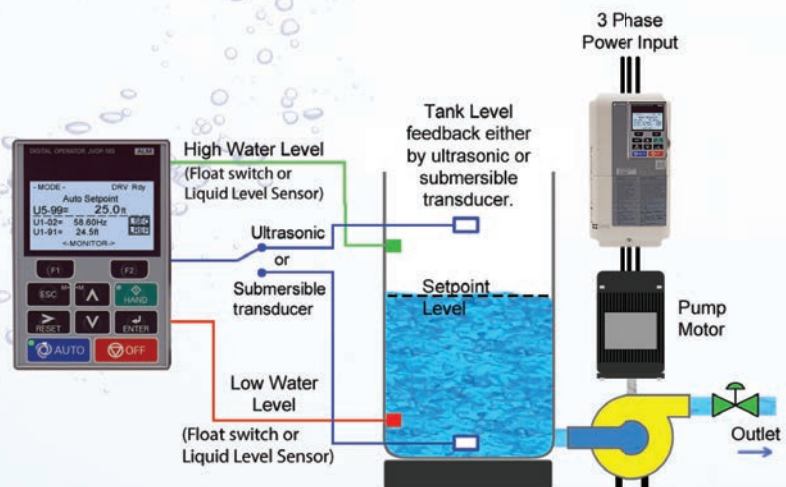
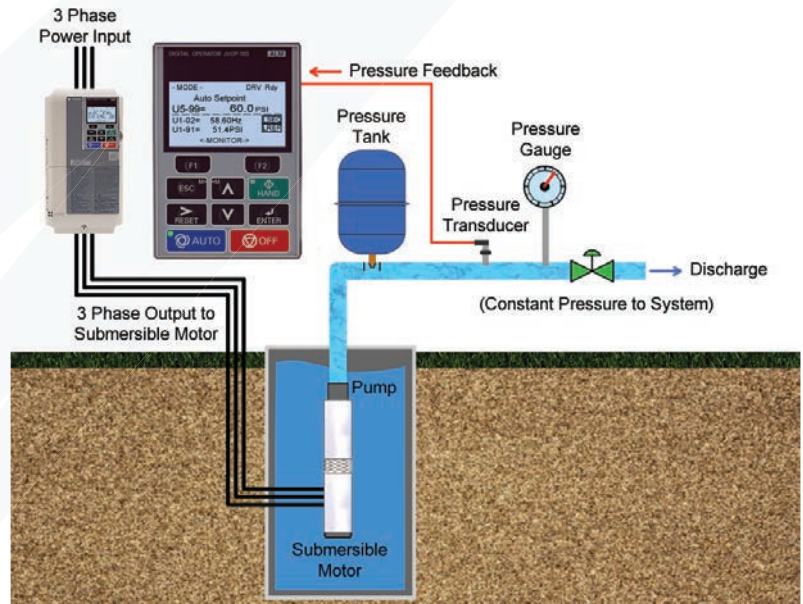

### APPLICATION REQUIREMENTS

- ▶ Sleep Mode Minimum Flow Protection
- ▶ No Flow / Deadhead Protection
- ▶ Submersible Motor Thrust Bearing Control
- ▶ Automatic System Restart
- ▶ Sleep Boost
- ▶ Low and High Pressure Feedback Detection
- ▶ Impeller Anti-jam Protection
- ▶ Constant Pressure with Well Drawn Down Control
- ▶ Power Loss Utility Start Delay Timer
- ▶ Loss of Prime (LOP) / Pump Dry-Run Protection
- ▶ Pre-Charge Control (Controlled Pipe Fill)
- ▶ Optional Dual Transducer Feedback for Redundancy
- ▶ Impeller De-scaling / De-ragging Control

# Drive with Constant Speed Lag Pump Multiplexing

## Overview

Many agricultural farms use multiple large verticle turbine pumps to provide pressurized water to large pivot irrigation systems. Applying a VFD to each of the booster pumps on these systems may not be practical. However, iQpump1000, using it's on-board digital outputs, can control up to 5 lag pump starters from a single VFD to maintain pressure by staging and de-staging the lag pumps.

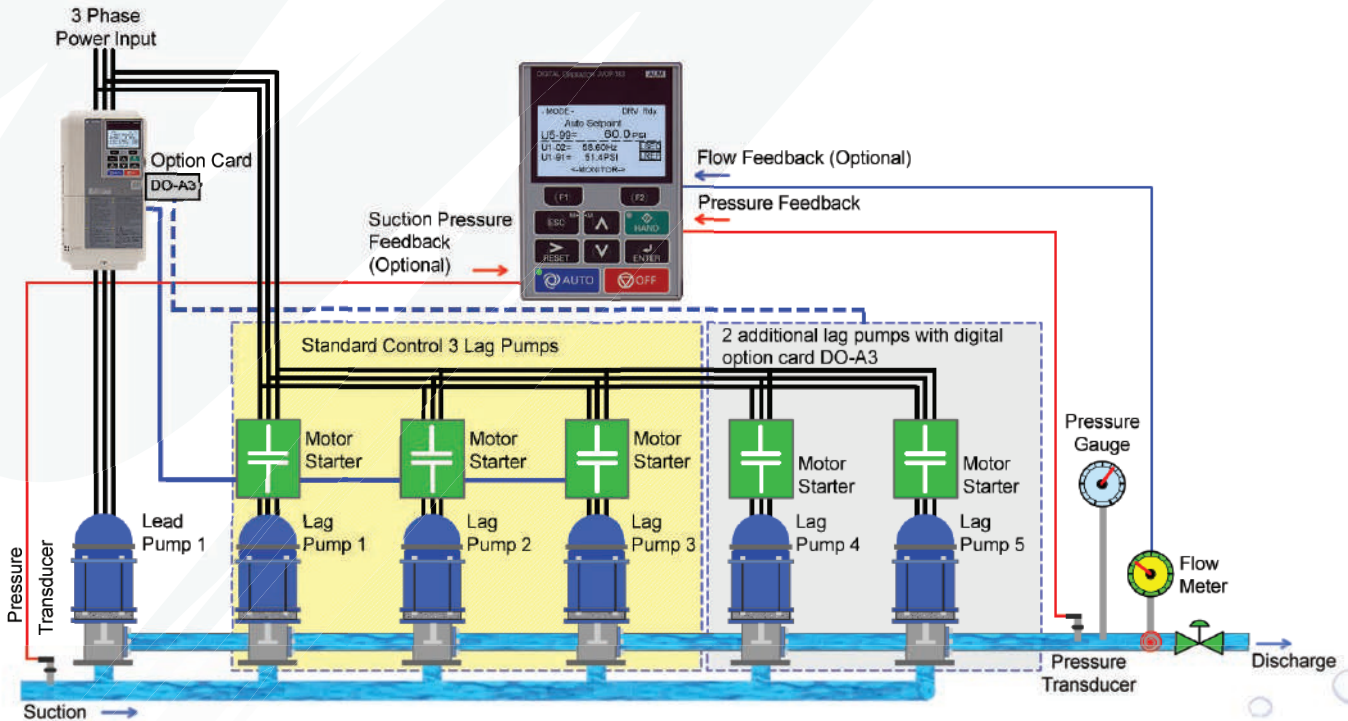

## APPLICATION REQUIREMENTS

- ▶ Inlet Suction Control
- ▶ Speed Reduction "Go To Speed" After Lag Pump Staging
- ▶ Setpoint Boost After De-staging
- ▶ Low Flow and High Flow (GPM) Protection
- ▶ Flow Meter Data Logging
- ▶ Lube Pump Control
- ▶ Hard Current Limit
- ▶ Back Spin Timer
- ▶ High Discharge Pressure Lag Pump Quick de-Staging

## Application Notes

- Automatically starts and stops up to 5 Lag pumps based on the system demand, and will automatically stage and de-stage the booster pumps.
- Alternation of lag pumps to provide even wear.
- Allows a single lag pump to be selected during Pre-Charge (Pipe-Fill) to reduce fill rate time.
- For large water consumers, acre-feet can be selected for water accumulation units.
- When the discharge pressure exceeds a high level setting, all running lag pumps will be quickly de-staged to prevent unsafe high pressure conditions.
- When using Pre-Charge, Lag Pump Staging and De-Staging functions, the drive's keypad will provide a message of time remaining before pre-charge is finished and/or time remaining before lag pumps are to stage and de-stage.





# Drive to Drive Multiplexing

## Overview

iQpump1000 has enhanced software not available in standard variable frequency drives, allowing for multiple drives to operate as a coordinated system. This allows pump system engineers the ability to add more modular pump systems together (Duplex, Triplex, etc.) to meet customer specifications and minimize cost by eliminating external control via PLC's and HMI's.

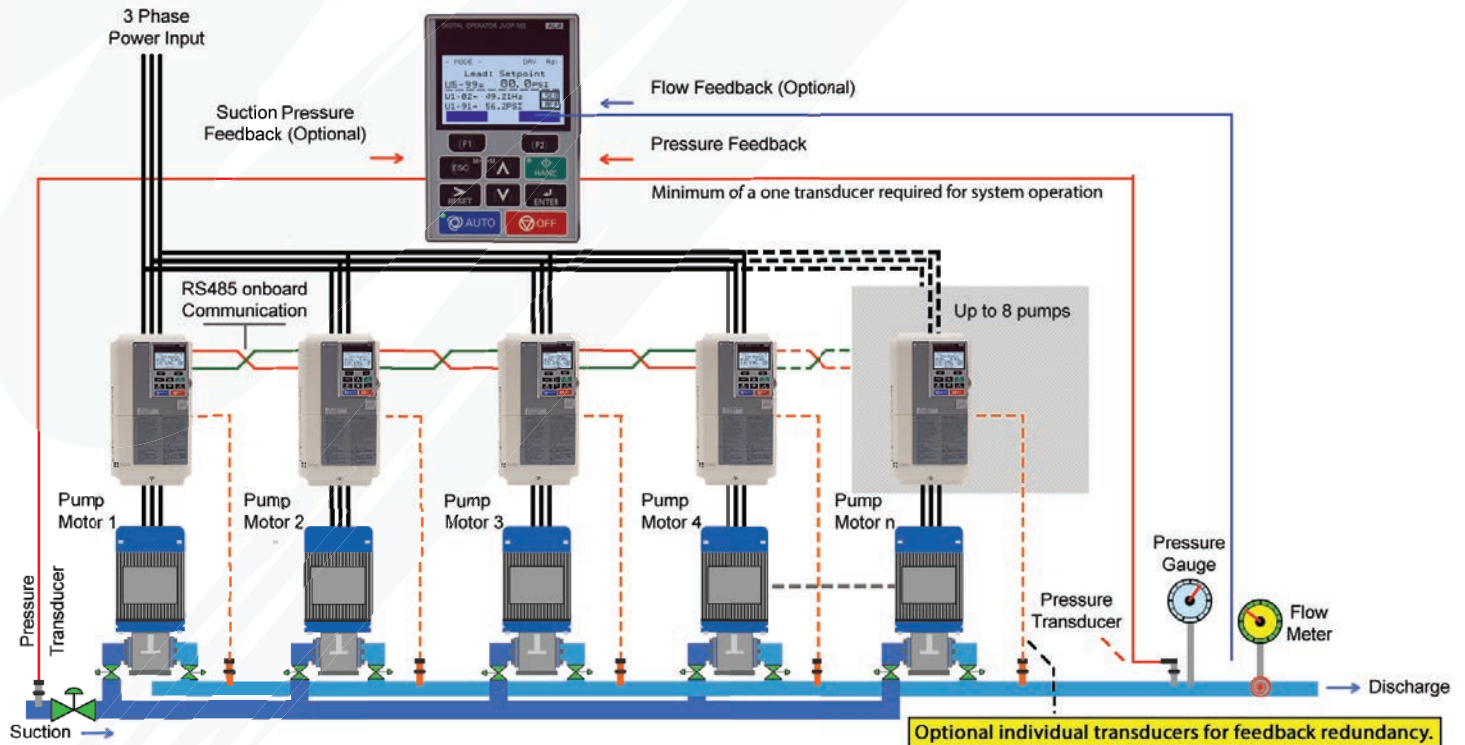

## APPLICATION REQUIREMENTS

- ▶ Pump Alternation
- ▶ Pump and Drive Redundancy
- ▶ Transducer Feedback Redundancy
- ▶ Pump Run Priority Selection
- ▶ Jockey Pump Control
- ▶ Pump Stage and De-Stage
- ▶ Lag Pump Lead Speed Follower Mode

## Application Notes

- Automatically alternates all pumps with a system programmable timer to provide even mechanical pump wear.
- Configurable transducer feedback settings to provide redundant backup if failure occurs.
- With the use of an optional suction transducer, all iQpump1000's will monitor inlet pressure with programmable PSI settings for faults, alarms and station controlled shutdown.
- Digital switch inputs for Low Suction / Low City Pressure / Low Water in Break Tank can be configured with selectable keypad message to match application.
- With the use of an optional flow input, all iQpump1000's can be configured to control staging and de-staging of lag pumps on GPM.

# Mechanical Installation Planning

## Drive Dimensions

### NEMA Type 1 [IP20] Diagram

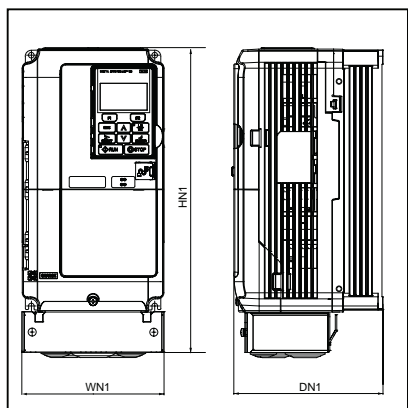

*iQpump1000 with NEMA Type 1 Kit Installed*

### Protected Chassis/External Heatsink Diagram

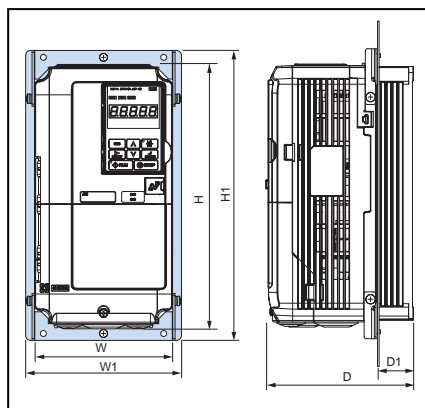

*iQpump1000 Protected Chassis / External Heatsink Configuration*

#### Notes:

1. The diagrams shown are simplified dimensional diagrams designed to display key outer dimensions of the drive. They are meant for planning purposes only. For more detailed dimensional/mounting data, please refer to the iQpump1000 dimensional drawings on [www.yaskawa.com](http://www.yaskawa.com)
2. Drives with NEMA Type 1 Enclosures can be converted to protected chassis by removing the top and bottom covers.
3. When mounting standard drives with heatsink external (NEMA 1 backside), the following models require a separately sold bracket kit: CIMR-PW2A0004Fxx to 0081Fxx, CIMR-PW4A0002Fxx to 0044Fxx, and CIMR-PW5A0003Fxx to 0032Fxx.  
Larger standard drives include brackets that must be detached from the back and reattached at the midpoint.

### 240V Class

Model CIMR-PW2A □□□□	Frame Size	Max. Applicable Motor Capacity (HP)	Dimensions (in.)									Weight (lb)	
			WN1	W	W1	HN1	H	H1	DN1	D	D1	NEMA 1	Protected Chassis
0004	1	0.75	5.51	5.51	7.64	12.06	10.24	11.81	5.79	5.79	1.34	7.3	--
0006		1.5	5.51	5.51	7.64	12.06	10.24	11.81	5.79	5.79	1.34	7.3	--
0008		2	5.51	5.51	7.64	12.06	10.24	11.81	5.79	5.79	1.34	7.5	--
0010		3	5.51	5.51	7.64	12.06	10.24	11.81	5.79	5.79	1.34	7.5	--
0012		3	5.51	5.51	7.64	12.06	10.24	11.81	5.79	5.79	1.34	7.5	--
0018	2	5	5.51	5.51	7.64	12.06	10.24	11.81	6.46	6.46	2.06	8.2	--
0021		7.5	5.51	5.51	7.64	12.06	10.24	11.81	6.46	6.46	2.06	8.2	--
0030	3	10	5.51	5.51	7.64	12.06	10.24	11.81	6.57	6.57	2.07	9.3	--
0040		15	5.51	5.51	7.64	12.06	10.24	11.81	6.57	6.57	2.07	9.3	--
0056	5	20	7.09	7.09	9.21	13.38	11.81	13.39	7.36	7.36	2.83	13.0	--
0069	6	25	8.66	8.66	11.65	15.47	13.78	16.54	7.76	7.76	2.91	20.1	--
0081		30	8.66	8.66	11.65	15.47	13.78	16.54	7.76	7.76	2.91	22.0	--
0110	7A	40	10.00	10.00	12.13	21.37	15.75	16.3	10.16	10.16	3.82	50.7	46.2
0138	8A	50	10.98	10.98	12.99	24.52	17.72	18.11	10.16	10.16	3.81	61.7	55.0
0169	10	60	12.95	12.95	15.2	30.08	21.65	22.13	11.14	11.14	4.21	90.2	81.4
0211		75	12.95	12.95	15.2	30.08	21.65	22.13	11.14	11.14	4.21	92.4	83.6
0250	11	100	17.95	17.72	22.05	37.80	27.76	28.54	12.99	12.99	5	191.8	167.6
0312		125	17.95	17.72	22.05	37.80	27.76	28.54	12.99	12.99	5	191.8	176.4
0360	12	150	19.84	19.69	23.62	45.98	31.50	32.28	13.78	13.78	5	233.7	216.1
0415		175	19.84	19.69	23.62	45.98	31.50	32.28	13.78	13.78	5	233.7	218.3

# Mechanical Installation Planning

## 480V Class

Model CIMR-PW4A □□□□	Frame Size	Max. Applicable Motor Capacity (HP)	Dimensions (in.)									Weight (lb)	
			WN1	W	W1	HN1	H	H1	DN1	D	D1	NEMA 1	Protected Chassis
0002	1	1	5.51	5.51	7.64	12.06	10.24	11.81	5.79	5.79	1.34	7.3	--
0004		2	5.51	5.51	7.64	12.06	10.24	11.81	5.79	5.79	1.34	7.3	--
0005		3	5.51	5.51	7.64	12.06	10.24	11.81	5.79	5.79	1.34	7.3	--
0007	2	3	5.51	5.51	7.64	12.06	10.24	11.81	6.46	6.46	2.06	8.2	--
0009		5	5.51	5.51	7.64	12.06	10.24	11.81	6.46	6.46	2.06	8.2	--
0011		7.5	5.51	5.51	7.64	12.06	10.24	11.81	6.46	6.46	2.06	8.2	--
0018	3	10	5.51	5.51	7.64	12.06	10.24	11.81	6.57	6.57	2.07	9.3	--
0023		15	5.51	5.51	7.64	12.06	10.24	11.81	6.57	6.57	2.07	9.3	--
0031	4	20	7.09	7.09	9.21	13.38	11.81	13.39	6.88	6.88	2.04	12.5	--
0038	5	25	7.09	7.09	9.21	13.38	11.81	13.39	7.36	7.36	2.83	13.0	--
0044	6	30	8.66	8.66	11.65	15.47	13.78	16.54	7.76	7.76	2.91	20.1	--
0058	7B	40	10.37	10.37	12.13	18.65	15.75	16.3	10.16	10.16	3.82	50.6	50.6
0072	8B	50	11.35	11.35	12.99	20.62	17.72	18.11	10.16	10.16	3.81	59.4	59.4
0088	9	60	13.32	13.16	15.35	25.16	20.06	21.34	10.27	10.27	3.97	85.8	79.2
0103		75	13.32	13.16	15.35	25.16	20.06	21.34	10.27	10.27	3.97	85.8	79.2
0139	10	100	12.95	12.95	15.2	30.08	21.65	22.13	11.14	11.14	4.21	99.0	90.2
0165		125	12.95	12.95	15.2	30.08	21.65	22.13	11.14	11.14	4.21	101	92.4
0208	11	150	17.95	17.72	22.05	37.80	27.76	28.54	12.99	12.99	5	191	174
0250	12	200	19.84	19.69	23.62	45.98	31.50	32.28	13.78	13.78	5	233	211
0296		250	19.84	19.69	23.62	45.98	31.50	32.28	13.78	13.78	5	246	224
0362		300	19.84	19.69	23.62	45.98	31.50	32.28	13.78	13.78	5	257	235
0414	13	350	20.29	20.29	25.39	48.3	37.4	40.55	14.68	14.68	5.19	292	275
0515	14	450	26.86	26.86	31.97	61.3	44.88	46.38	14.72	14.72	7.71	504	475
0675		600	26.86	26.86	31.97	61.3	44.88	46.38	14.72	14.72	7.71	515	486
0930	15	800	50.2	49.61	--	80.4	54.33	--	14.73	14.91	--	1394	1195
1200		1000	50.2	49.61	--	80.4	54.33	--	14.73	14.91	--	1420	1221

## 600V Class

Model CIMR-PW5A □□□□□	Frame Size	Max. Applicable Motor Capacity (HP)	Dimensions (in.)									Weight (lb)	
			WN1	W	W1	HN1	H	H1	DN1	D	D1	NEMA 1	Protected Chassis
0003	1	2	5.51	5.51	7.64	12.06	10.24	11.81	5.79	5.79	1.34	7.3	--
0004		3	5.51	5.51	7.64	12.06	10.24	11.81	5.79	5.79	1.34	7.3	--
0006	2	5	5.51	5.51	7.64	12.06	10.24	11.81	6.46	6.46	2.06	8.2	--
0009		7.5	5.51	5.51	7.64	12.06	10.24	11.81	6.46	6.46	2.06	8.2	--
0011	3	10	5.51	5.51	7.64	12.06	10.24	11.81	6.57	6.57	2.07	9.3	--
0017	5	15	7.09	7.09	9.21	13.38	11.81	13.39	7.36	7.36	2.83	13.0	--
0022		20	7.09	7.09	9.21	13.38	11.81	13.39	7.36	7.36	2.83	13.0	--
0027	6	25	8.66	8.66	11.65	15.47	13.78	16.54	7.76	7.76	2.91	20.1	--
0032		30	8.66	8.66	11.65	15.47	13.78	16.54	7.76	7.76	2.91	20.1	--
0041	8B	40	11.35	11.35	12.99	20.62	17.72	18.11	10.16	10.16	3.81	59.4	59.4
0052		50	11.35	11.35	12.99	20.62	17.72	18.11	10.16	10.16	3.81	59.4	59.4
0062	10	60	12.95	12.95	15.2	30.08	21.65	22.13	11.14	11.14	4.21	99.0	90.2
0077		75	12.95	12.95	15.2	30.08	21.65	22.13	11.14	11.14	4.21	99.0	90.2
0099		100	12.95	12.95	15.2	30.08	21.65	22.13	11.14	11.14	4.21	99.0	90.2
0125	11	125	17.95	17.72	22.05	37.80	27.76	28.54	12.99	12.99	5	191	174
0145		150	17.95	17.72	22.05	37.80	27.76	28.54	12.99	12.99	5	191	174
0192	12	200	19.84	19.69	23.62	45.98	31.50	32.28	13.78	13.78	5	233	235
0242		250	19.84	19.69	23.62	45.98	31.50	32.28	13.78	13.78	5	257	235

We take quality personally at Yaskawa. Our drives and servo packages offer the highest MTBF in the world. The relationships we have with our customers ensure mutual benefits. The partnerships we cultivate with our distributors add value to the way we work with you. We hire great people and continuously train them to be able to serve your needs better. We deliver product on time. It works out of the box. We answer questions promptly and never say, "we can't."

To us, quality means doing everything we can to make our customer, partner, and employee experiences great.

We commit to that philosophy every day. We make it happen. We can because, to us,  
IT'S PERSONAL.



**Yaskawa America, Inc.**  
Drives & Motion Division

2121 Norman Drive South  
Waukegan, IL 60085

1-800-YASKAWA (927-5292) • Local: 847-887-7000 • Fax: 1-847-887-7310

DrivesHelpDesk@yaskawa.com • [www.yaskawa.com](http://www.yaskawa.com)

Document BL.iQp1000.01 01/15/14 • © 2014

